

Package Dimensions

3.2x1.6mm SMD CHIP LED LAMPS

EPT3216SRC

SUPER BRIGHT RED

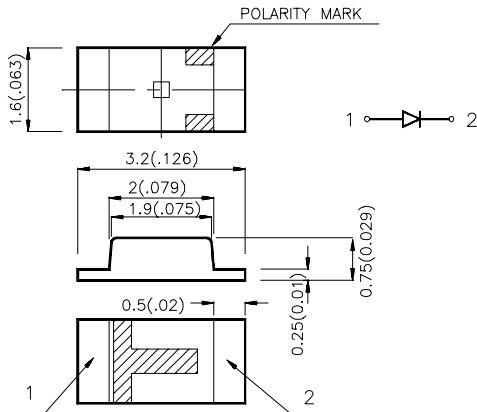

Notes:

1. All dimensions are in millimeters (inches).
2. Tolerance is $\pm 0.2(0.0079)$ unless otherwise noted.
3. Lead spacing is measured where the lead emerge package.
4. Specifications are subject to change without notice.

Features

1. 3.2mmx1.6mm SMT LED, 0.75mm THICKNESS.
2. LOW POWER CONSUMPTION.
3. WIDE VIEWING ANGLE.
4. IDEAL FOR BACKLIGHT AND INDICATOR.
5. VARIOUS COLORS AND LENS TYPES AVAILABLE.

Description

The Super Bright Red source color devices are made with Gallium Aluminum Arsenide Red Light Emitting Diode.

Selection Guide

Part No.	Emitting Color +Material	$\lambda D(nm)$	Lens Type	Iv (mcd) @ 20 mA		Viewing Angle
				Min.	Typ.	2 θ 1/2
EPT3216SRCPRV	GaAlAs	640	WATER CLEAR	20	70	120°

Note:

1. θ 1/2 is the angle from optical centerline where the luminous intensity is 1/2 the optical centerline value.

Electrical / Optical Characteristics at $T_A=25^\circ\text{C}$

Symbol	Parameter	Device	Typ.	Max.	Units	Test Conditions
λ_{peak}	Peak Wavelength	Super Bright Red	660		nm	$I_F=20\text{mA}$
λ_D	Dominate Wavelength	Super Bright Red	640		nm	$I_F=20\text{mA}$
$\Delta\lambda_{1/2}$	Spectral Line Halfwidth	Super Bright Red	20		nm	$I_F=20\text{mA}$
C	Capacitance	Super Bright Red	45		pF	$V_F=0\text{V}; f=1\text{MHz}$
V_F	Forward Voltage	Super Bright Red	1.85	2.5	V	$I_F=20\text{mA}$
I_R	Reverse Current	All		10	μA	$V_R = 5\text{V}$

Absolute Maximum Ratings at $T_A=25^\circ\text{C}$

Parameter	Super Bright Red	Units
Power dissipation	100	mW
DC Forward Current	30	mA
Peak Forward Current [1]	155	mA
Reverse Voltage	5	V
Operating/Storage Temperature	-40°C To +85°C	

Note:

1. 1/10 Duty Cycle, 0.1ms Pulse Width.

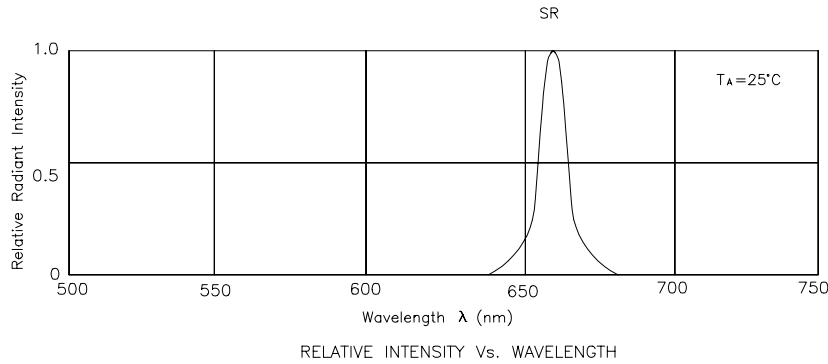

Super Bright Red EPT3216SRC

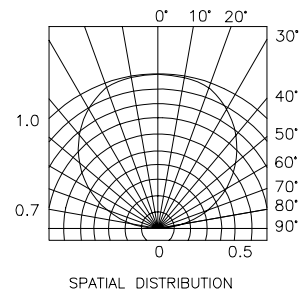
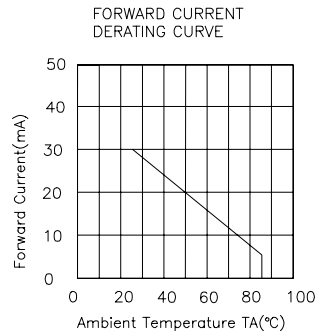
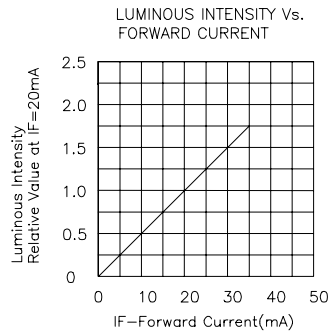
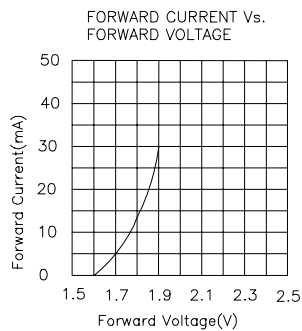

EPT3216SRC SMT Reflow Soldering Instructions

Number of reflow process shall be less than 2 times and cooling process to normal temperature is required between first and second soldering process."

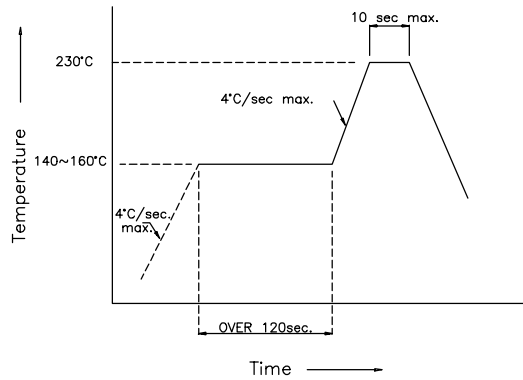

EPT3216SRC Recommended Soldering Pattern (Units : mm)

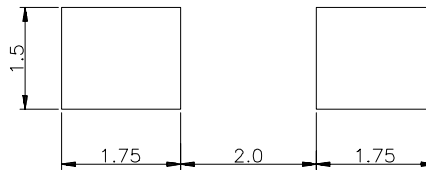

EPT3216SRC Tape Specifications (Units : mm)

PACKAGE : 2000PCS / REEL

